



# BEAR RIVER **ZEOLITE** BRZ™

## WATER FILTRATION AND TREATMENT

**BEAR RIVER ZEOLITE BRZ™** is a naturally occurring volcanic rock that contains the zeolite mineral called "clinoptilolite". The rock is drilled, blasted, crushed and screened to various sizes. BRZ™ is one of the best zeolites in the world because:

- BRZ™ contains more than 90% clinoptilolite and therefore it holds a high amount of ammonium and other cations.
- It contains very little sodium, which is toxic to plants and causes hard pan in clay soils.
- It contains no crystalline silica and is not a cause for silicosis.
- BRZ™ is a natural cation exchange agent that has a CEC of 190-200 meq/100 grams.
- BRZ™ has a rough surface that traps fine particles for increased filtration.
- BRZ™ is highly porous and holds up to 55% of its weight in water, while sand only holds 5%.
- Porosity increases flow rates.
- BRZ™ is low cost.



### BRZ™ PRODUCTS FOR:

**Drinking Water Filtration**

**Swimming Pool Filtration**

**BRZ™ Filter Media**

**Waste Water Flocculation**

**Cation Exchange Process**

**Oil Spill Removal From Water**

# DRINKING WATER FILTRATION

## APPLICATIONS

- Sand/anthracite and multimedia bed replacements in municipal water treatment plants.
- Surface and ground water filtration.
- Economical filter beds upstream from RO (reverse osmosis) and nano-membrane plants.

## BENEFITS

### Better Filtrate Clarity

Typical sand/anthracite filter beds have a 12 to 15 micron nominal filter rating. BRZ™ typically has a nominal filter rating of less than 5 microns. This greatly reduces the effluent turbidity, generally measured in Nephelometric Turbidity Units (NTUs).

### Lower Capitol Requirement To Increase Filtration Capacity

The capacity of a sand/anthracite municipal water plant can be doubled with no additional cost by switching the filter media to BRZ™.

### Better Cleaning

Backwash, especially with air sparge, efficiently cleans bed granules.

### Fewer Backwash Cycles

BRZ™ requires only one half of the backwash cycles that are required by sand/anthracite.

### Less Backwash Water

The fewer backwash cycles generally cut the amount of backwash water by one third to one half. This means treating less backwash water and greater plant treatment capacity.

### Greater Loading Due To Greater Surface Area

BRZ™ generally has 6 to 7 times the surface area as sand. This makes BRZ™ a much better filter media with greater holding capacity.

### Removal of Contaminants

BRZ™ removes metals (refer to table on page 5), radioactive elements, pathogens, nitrogen, certain organic hydrocarbons, and many other contaminates.

### Long Filter Bed Life

The anticipated filter bed life of BRZ™ is more than 10 years. Other zeolites contain clay which drastically shortens the life of the filter bed.

### Increases Flow Rates In Gravity Systems

In a sand/anthracite filter media system the flow rate is typically 1.2 to 2.0 gpm per square foot. In a BRZ™ filter media system, the flow rate is typically in the 4.0 gpm per square foot range.



## COMPARISON OF ZEOLITE FILTER PERFORMANCE VS CONVENTIONAL MEDIA: Gravity Flow Beds

Filter Media	Bed Composition	Filtration Rating (nominal)	Solids Loading Capacity
Sand (2 gpm/ft <sup>2</sup> )	20 x 40 mesh	~20μ	1X
Sand/Anthracite (2 gpm/ft <sup>2</sup> )	#1 anthracite (66%) 20 x 40 mesh sand (34%)	~15μ	1.4X
BRZ™ (4 gpm/ft <sup>2</sup> )	14 x 30 mesh (100%)	~5μ	2.6 - 2.8X

### Increases Flow Rates In Pressure Vessel Systems

In a sand/anthracite pressure vessel filter system the flow rates are typically 6 to 7 gpm per square foot. In a BRZ™ pressure vessel filter system the flow rates are typically in the 12 to 15 (and sometimes 20) gpm per square foot range.

## COMPARISON OF ZEOLITE FILTER PERFORMANCE VS CONVENTIONAL MEDIA: Pressure Vessels

Filter Media	Bed Composition	Filtration Rating (nominal)	Solids Loading Capacity
Sand (6-12 gpm/ft <sup>2</sup> )	20 x 40 mesh (100%)	~20μ	1X
Sand/Anthracite (6-12 gpm/ft <sup>2</sup> )	#1 anthracite (66%) 20 x 40 mesh sand (34%)	~15μ	1.4X
Multimedia (10-12 gpm/ft <sup>2</sup> )	#1 anthracite (45%) 20 x 40 mesh sand (30%) #50 garnet (15%) #16 garnet (10%)	~12μ	1.6X
BRZ™ (10-12 gpm/ft <sup>2</sup> )	14 x 30 mesh (100%)	~5μ	2.8X



### Simpler Handling

BRZ™ beds simplify filter bed material handling.

### pH Modulation

BRZ™ will tend to make slightly acidic (e.g. pH - 5.5-6.0) water more near neutral.

### Land Application of Spent BRZ™ Filter Bed

Under most conditions, the spent BRZ™ filter bed can be recycled as a soil amendment for lawns and gardens instead of disposing at industrial waste or HAZMAT sites.



## BRZ™ WATER FILTRATION SPECIFICATIONS

Size	14 x 30 mesh
Weight	Density 55 pounds per cubic foot (880 kgs/cubic meter)
Sieve analysis	Uniformly coefficient 1.8
Color	Pale green when dry, dark green when wet
Average particle size	0.7 mm
Uniformity index	1.9
Surface Area	24.9 square meters per gram
Hardness	Low clay, hard, abrasion resistant

## SWIMMING POOL FILTRATION

### APPLICATION

Typically, 25 to 30 pounds of BRZ™ replaces 50 pounds of sand.

### BENEFITS

#### Less material for higher coverage

A 25 pound bag of BRZ™ has the surface area of over 50 NFL football fields, while a 50 pound bag of sand only covers one football field.

#### Increased flow rate

#### DE (diatomaceous earth) like clarity

BRZ™ has is a nominal 3 to 5 micron filter rating.

#### Reduces backwash time by up to 50%

#### Higher loading capacity than sand

BRZ™ has an extensive surface area for greater filtration.

#### Less chlorine is needed

BRZ™ exchanges ammonium from urine directly into the crystal lattice where it is not water soluble, reducing the level of chlorination.

#### Reduces eye irritation

Less chlorine is used and fewer chloramines (that burn the eyes) are formed.

#### Life expectancy is the same as sand

#### Simple disposal

Used BRZ™ can be applied as a soil amendment for gardens and potted plants.



# BRZ™ FILTER MEDIA BASICS

## BRZ™ FOR PHYSICAL FILTRATION BARRIER TO PATHOGENS SUCH AS BACTERIA AND BACTERIAL SPORES

Physical filtration barriers for accumulation or collection of microorganisms in water that endanger human health have been in focus during the last several years. Under certain conditions, BRZ™ collects pathogens, such as *Giardia*, *Cryptosporidium*, bacteria and their spores. Most of these organisms and their spores are in the size range of 0.5-10 micrometers (microns). In contrast, the water permeable pores in BRZ™ are mostly smaller than .05 microns; therefore the zeolite fragment or granule can “surface collect” a high percentage of these microorganisms while the water passes through the zeolite fragment.

The U.S. drinking water standards for microorganism pathogens, and turbidity can be more easily met using a natural, relatively low-cost material, such as BRZ™ rather than “sand”, which is chiefly quartz grains.

### The advantages of using BRZ™ in physical filtration systems:

- The high internal and external surface area of BRZ™ (@25m<sup>2</sup>/g) exceeds that of quartz by more than 10 times.
- BRZ™ fragments tend to be discoid shaped, rather than round, thus presenting a large surface area (per unit of mass).
- BRZ™ pore space permeability for water transmission through the grains or fragments is 100% better when compared to non-permeable quartz grains.

### WATER PATHS FOR QUARTZ VERSUS BRZ™ IN FILTRATION

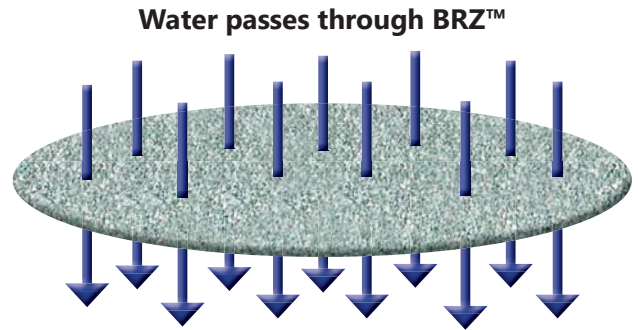
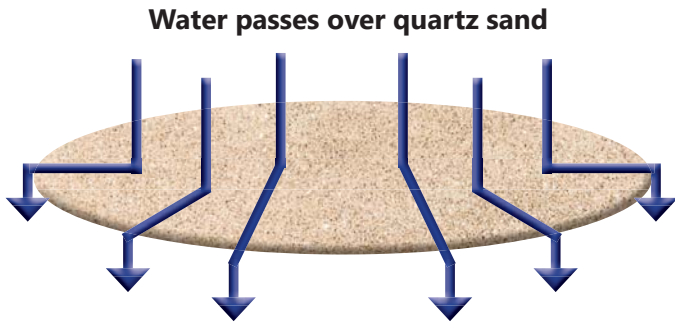

- The amount, or layer thickness of BRZ™ in the filtration systems can be much thinner (smaller volume) than quartz sand systems - because of the high “surface area and permeable pore space” of BRZ™.
- The density of 2-4 mm granules of BRZ™ is about 55-60 lb/ft<sup>3</sup>, which is about half of that of quartz grains of similar size. Thus the volume of one ton of BRZ™ is twice that of quartz sand.

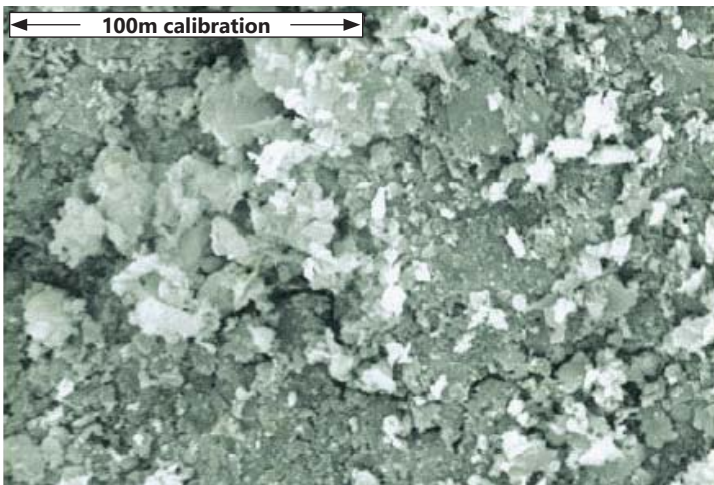

Figure 1. SEM photomicrograph of a BRZ™ showing micromineral, projections on the surface. (Note the 100m calibration bar at the upper left). The micro-projections effectively trap suspended solids in water.

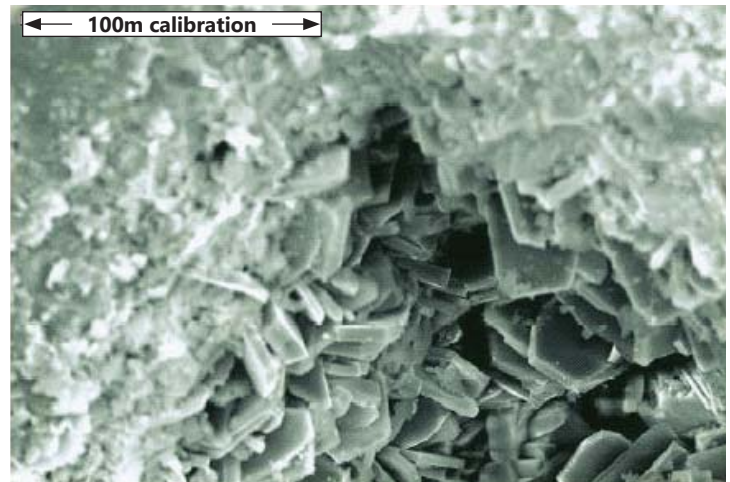

FIGURE 2 – High magnification (SEM) of a BRZ™ granule showing detail of the mineral, micro-projections. (Note the calibration bar at the upper left).



# WASTE WATER FLOCCULATION

## BRZ™ FLOCCULATION SPECIFICATIONS

Size	-40 mesh (fine powder)
Weight	Density 55 pounds per cubic foot (880 kgs/cubic meter)

## APPLICATIONS

Minus 40 mesh BRZ™ is an advanced, surface water turbidity, silt sorption and flocculation product developed for municipal drinking water plants and industrial pumping stations. BRZ™ doses of 2-3lb/1000 gal of surface water are used for auger or slurry fed treatment (higher turbidity water requires higher doses). The sorbed/flocculated solids are granular with a specific gravity of 1.2 to 1.4. The specific gravity of BRZ™ is 2 to 2.1, which enhances rapid settling.

- Drinking water-alum & polymer flocculation chemistry replacement.
- Turbidity, silt, algae (bio-particle) & TOCs removal from surface water.
- Enhances clarification performance; decreases filter bed solids loading.



## BENEFITS

### Better Solid/Liquid Separation than Alum and Polymer

The specific gravity of the alum/polymer floccules is 1.03 and this results in many "pin flocs" that do not settle. The specific gravity of the BRZ™ is 1.4 and this results in a clean solid/liquid separation and interface giving better clarity.

### BRZ™ System Reagent Not Bulky

The alum/polymer reagent is bulky and hard to handle compared to the BRZ™ system.

### Apply Spent BRZ™ Reagent on Land

The spent alum/polymer reagent must be taken to a licensed land fill.

### Lower Cost with BRZ™

Although the reagent cost of the BRZ™ systems is about 10% higher than the alum/polymer system the overall cost is much less due to easier dewatering and a lower solids management cost.

### Better Removal of Heavy Metals, Certain Hydrocarbons, Chloramines, and Ammonium

## CATION AND ANION REMOVAL

### Cation Removal

BRZ™ is a negatively charged cation exchange agent. As a result of its high cation exchange capacity, BRZ™ is able to exchange various cations (ions with a positive charge) into its lattice depending on their molecular size, competing cations, and concentrations. During the cation exchange process, cations move from the BRZ™ mineral lattice and are replaced by other cations, which are held in a non-water soluble state within the lattice.

### Anion Removal

Bear River SMZ (surface modified zeolite) is also available for anion removal. The negative surface charge of BRZ™ is modified to a positive charge, which allows the exchange of anions (ions with a negative charge) into the lattice. The alteration in charge allows the mineral to remove anions, such as bicarbonates (HCO<sub>3</sub>-1), carbonates (CO<sub>3</sub>-2), sulphates (SO<sub>3</sub>-1), sulfites (SO<sub>3</sub>-1), chlorides (CL-1) arsenates (As-1), nitrates (NO<sub>3</sub>-1), nitrites (NO<sub>2</sub>-1) and phosphates (PO<sub>4</sub>-3).

### Partial list of Cations Removed by BRZ™

Radicals	Heavy Metals	Light Metals	Radioactive Elements
Ammonium NH <sub>4</sub>	Lead Pb	Sodium Na	Radium Ra
	Zinc Zn	Potassium K	Uranium U
	Cadmium Cd	Calcium Ca	Strontium Sr
	Copper Cu	Aluminum Al	Cesium Cs
	Iron Fe	Magnesium Mg	
	Manganese Mn		
	Antimony Sb		
	Mercury Hg		
	Nickel Ni		
	Cobalt Co		
	Beryllium Be		
	Zirconium Zr		
	Arsenic As		
	Chromium Cr		
	Thallium Tl		
	Rubidium Rb		
	Silver Ag		
	Barium Ba		
	Selenium Se		
	Molybdenum Mo		

# CATION EXCHANGE PROCESS

BRZ™ has two ways of holding cations (positive ions; such as ammonium, calcium, sodium, and potassium). The first way is in its crystal lattice where the ammonium and other cations are held and are not water soluble. The second way is in its channel-ways where BRZ™ can hold up to 55% of its weight in water. In this case the cations are more loosely held and are water-soluble. BRZ™ is an excellent desiccant.

## ION EXCHANGE FLOW DIAGRAM

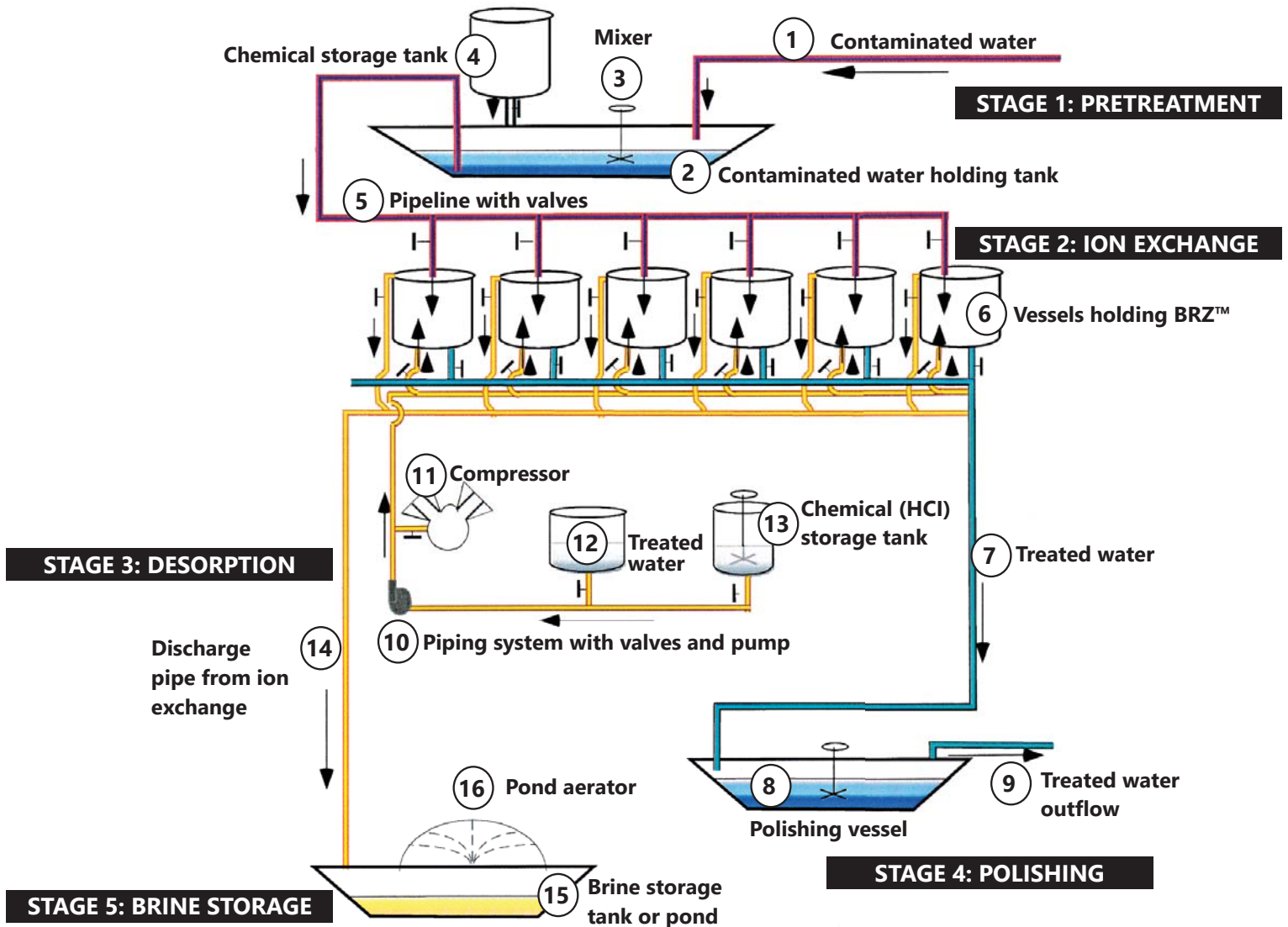

## ION EXCHANGE FLOW PROCESS

<b>STAGE 1</b>	Incoming contaminated water enters the holding tank for storage, homogenizing, and pretreatment for problematic cations, anions, gases, and particulates. Water is agitated and treated with chemicals
<b>STAGE 2</b>	Pretreated water is processed in ion exchange vessels, treated with hydrochloric acid and rinsed.
<b>STAGE 3</b>	Desorption of chemicals from treated effluent.
<b>STAGE 4</b>	Final chemical adjustment and aeration then discharge to a river, irrigation system, etc.
<b>STAGE 5</b>	Effluent enters brine storage vessel or lined earthen dam for further concentration of sodium by aeration.

# EXCHANGE VESSEL OPERATION

**Ion Exchange Stage**  
(elevation view)

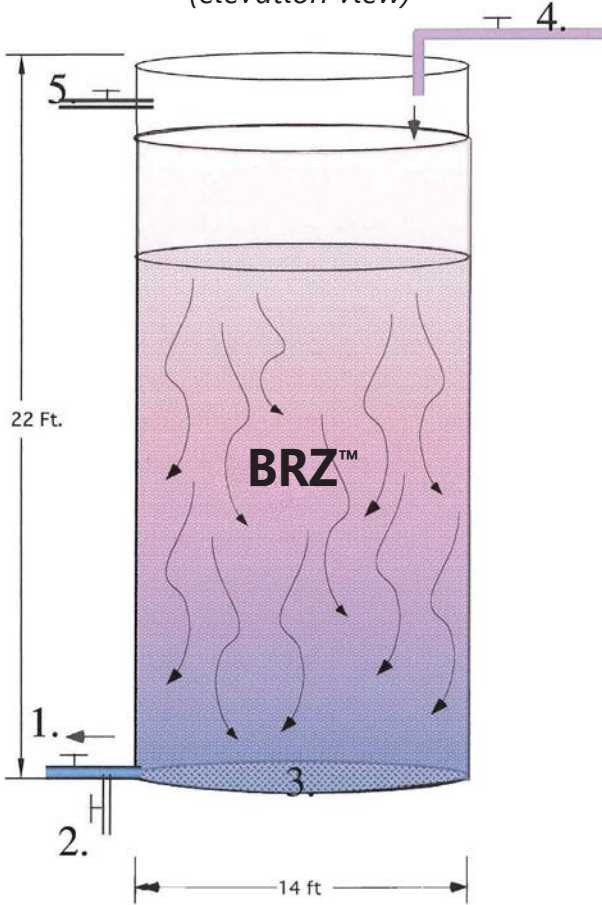

**Backwash Operation**  
(elevation view)

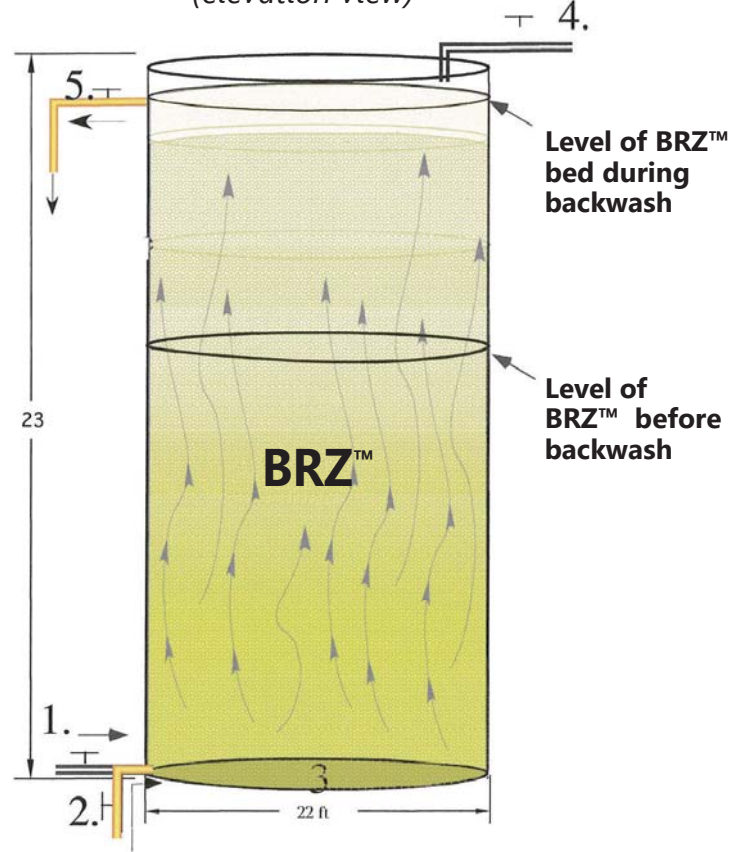

**Vessel Bottom**  
(plan view)

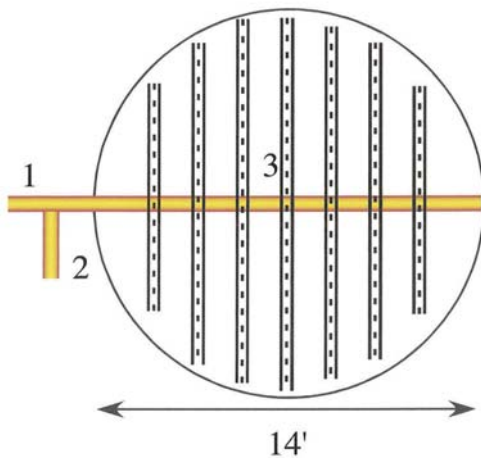

**Key to diagrams**

1. Discharge pipe to discharge or other cation exchange vessel.
2. Pipe to clean sediment from ion exchange bed or for the regeneration of BRZ™.
3. Piping system with holes in bottom of the ion exchange vessel.
4. Inlet pipe for contaminated water.
5. Discharge pipe for backwashing or regenerating.





# OIL SPILL REMOVAL FROM WATER



**BRZ™ is sold as an absorbent for oil for floor applications, spills, and many other applications.**

## BRZ™ OIL REMOVAL SPECIFICATIONS

Size	-40 mesh or as fine as 20-25 microns
Surface Area	24.9 Square meters per gram
Oil capacity	Absorbs up to 30% of its weight in oil

## BENEFITS

### Surface application

When surface applied to remove oil sheen, the dry dust floats by virtue of the air in the numerous channel-ways in the mineral.

### Oil containment

The floating mineral adsorbs the oil and the specific gravity of the mineral increases. At a saturated level, the mineral coagulates into a clump and sinks. The oil sheen is removed.

Depending on the thoroughness of the mixing, BRZ™ will hold the oil indefinitely on the sea floor or bottom. In the case of an oil-sheen, all the oil enters the mineral channel-ways and is permanently encapsulated after it sinks.

### BRZ™ removes heavy concentrations of oil

In the case of massive amounts of oil, the oil will initially sink when absorbed by BRZ™. Larger globules are released back to the surface and will be contained by additional BRZ™ treatment.

### BRZ™ can be inoculated with oil digesting microbes

## APPLICATION

- BRZ™ can be applied as a dust on the surface of water that has an oil-sheen, because dry dust floats by virtue of the air in the numerous mineral channel-ways.
- BRZ™ can be applied from aircraft or from vessels.
- BRZ™ can be dispersed as a dust by disc distributors, pneumatic-venturi guns, or many other methods.

